



**BIRD•B•GONE** INC. *Installation and Applications*

# Spike 2000™

## Features

Bird-B-Gone Spike 2000 is constructed of durable polycarbonate plastic with U.V. Inhibitors. It is the most cost effective, permanent protection against bird landings. It is non-conductive and provides the widest coverage of any bird deterrent: 7". Bird-B-Gone Spike 2000 is easy to install on ledges, beams, parapets, sills, pipes, roof peaks, chimneys, post piling, signs and any where birds are landing and being a nuisance.

**Spike 2000** will repel all species of birds.

**Colors:** Spike 2000 is available in White, Tan, Grey, Black, Brown, Brick Red and Crystal Clear. Custom colors also available.

**Packaging:** Spike 2000 is packaged with twenty-five 2 ft. sections per box. One box contains 50ft. of protection.

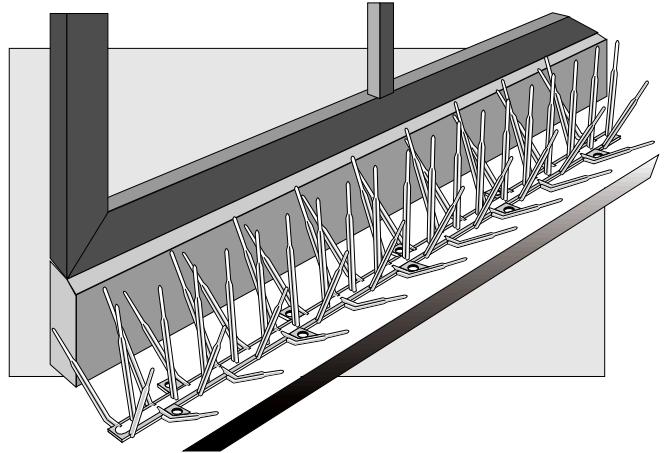

## Applications

Bird-B-Gone Spike 2000 is a versatile system that can be easily installed where any bird can roost.

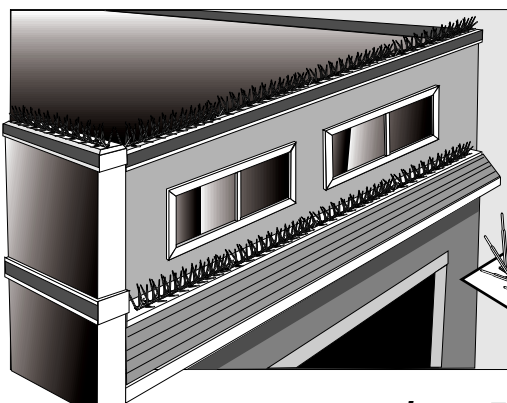

**Ledges:**  
Most often, Pest birds congregate on ledges and roof tops. Install Spike 2000 to keep birds from creating unsightly messes.

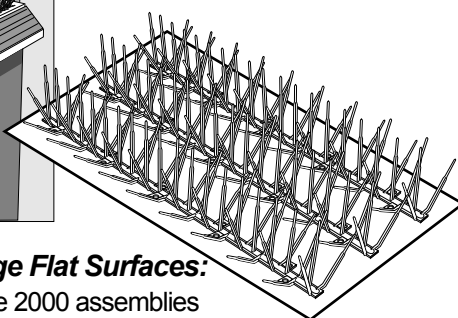

**Large Flat Surfaces:**  
Spike 2000 assemblies can be installed in multiple rows for wide area coverage.

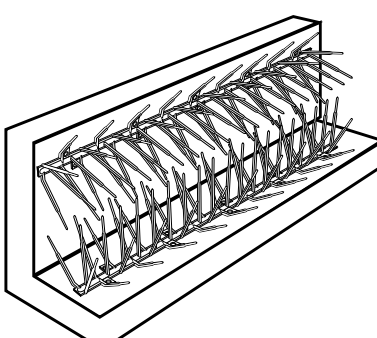

**Nesting Areas:**  
Many times pigeons nest in a specific area for generations. Preventing nesting takes a special installation using intertwining vertical and horizontal rows.

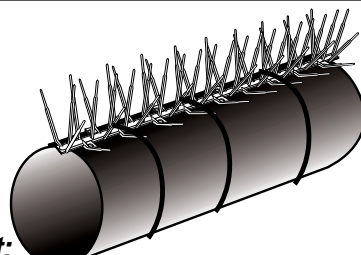

**Conduit:**  
Spike 2000 can be attached to wires, conduit, gutters, and pipes by using common hose clamps, Nylon ties or wire lashings.

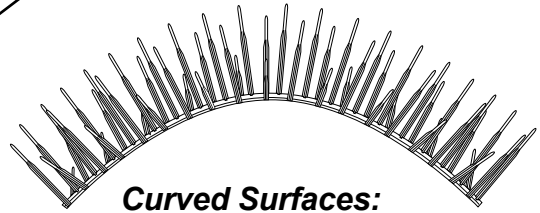

**Curved Surfaces:**  
Spike 2000 is flexible and can be installed on curved surfaces (such as lampposts or signs) by using common hose clamps, nylon ties or wire lashings.

**IMPORTANT!** *Observe all Cautions and Warnings listed in instructions prior to installation.*

*See reverse side.*

# INSTALLATION INSTRUCTIONS FOR BIRD•B•GONE "SPIKE 2000" SYSTEM

## CAUTION!

READ AND FOLLOW ALL INSTRUCTIONS PRIOR TO ATTEMPTING TO INST ALL BIRD-B-GONE SPIKE 2000. SPIKES ARE **SHARP ...** BE SURE TO WEAR GLOVES AND SAFETY EYE WEAR. KEEP OUT OF REACH OF CHILDREN AND PETS. DO NOT INSTALL WHERE HUMAN PHYSICAL CONTACT IS POSSIBLE.



**1.** Thoroughly clean all surfaces where the product is to be installed. Suggestion: Use a 10% bleach or ammonia solution to disinfect that area. It is important that all debris is removed including overhanging branches, leaves, nests, etc. before disinfecting.

**5.** For heavy infestation/nesting areas: Getting rid of pest birds that have been in an area for generations may take some extra effort. Spike 2000 should be installed horizontally on the surface and vertically across the back wall. Intertwine spikes as shown. (Illus #4)

**DUE TO THE INFECTIOUS DISEASES ASSOCIATED WITH BIRD FECES, BE SURE TO USE EXTREME CARE WHEN REMOVING NESTS AND BIRD DROPPINGS.**

**2.** Determine method of attaching Spike 2000 to surface.

- **For Wood:** Use #8 Wood screws. You will need 10 - #8 wood screws for every 2ft. section of spikes.
- **For Concrete, Brick, Steel:** Use Outdoor Construction Adhesive that is not silicon based. Call Bird-B-Gone for recommended adhesives. One caulking tube of adhesive should cover at least 30 ft. of Spike.

**3.** When using adhesives:

- Run a bead line of adhesive down the glue line trough on the under side of the spike strip. (Illus # 1) Also put a dollop of adhesive on each of the screw holes. this will allow the glue to mushroom up through holes and adhere more effectively ( Illus # 1)
  - Carefully place strip on to surface. Remember to over hang strip 1/2" from edge of surface... And be sure that no more than 1/2" is left to back of wall. (Illus. # 2)
  - When placing the next strip of spikes, be sure to place " End A " to " End B "
- End-A Starts with vertical center spike.  
End-B Starts with two middle spikes offset at an angle. (Illus # 3)

**Note:** Whenever possible - Screw or bolt down the spikes in conjunction with using an Outdoor Construction Adhesive.

**4.** Adapting to size:

Spike 2000's unique design has break away points between each set of screw holes. You can bend and twist the product at these points to break off section as needed. Tin snips/Hacksaw, etc. can be used to cut the product to any desired size. (Illus # 1)

**1.** GLUE TROUGH FOR EASY AND NEAT GLUING

OFFSET PRE DRILLED HOLES FOR SCREW ATTACHMENT

NOTCHES FOR EASY CUTTING TO ROW SIZE

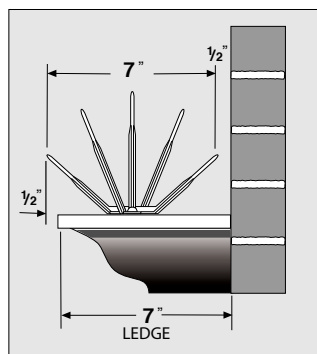
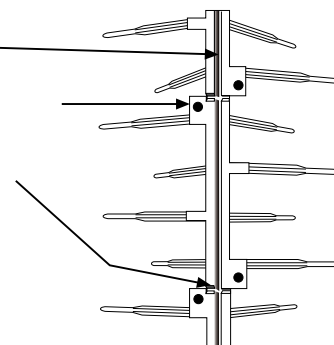

**2.** Over hang spikes 1/2" No more than 1/2" to back wall

**3.** Apply End-A to End-B Only

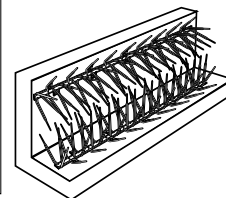
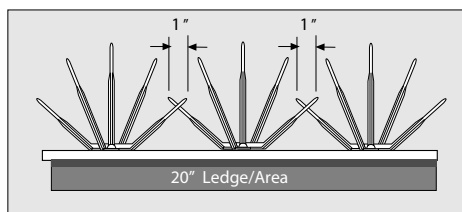
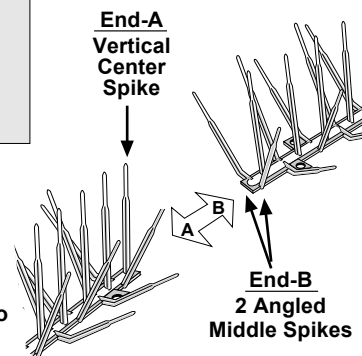

**4.** For Wide areas and Heavy infestations - Intertwine spikes with 1" overlap on both vertical and horizontal surfaces.

Any Questions Regarding SPIKE 2000 Installation

call **1-800-392-6915**

Fax: 949 472 3116  
Tel: 949 472-3122

Web site [www.birdbgone.com](http://www.birdbgone.com)  
E-Mail: [nobirds@birdbgone.com](mailto:nobirds@birdbgone.com)

**BIRD•B•GONE** INC.

23918 Skyline • Mission Viejo, CA 92692

